

# Polyphase AC Induction Motor TROUBLESHOOTING GUIDE

Properly installed and maintained Lincoln Electric polyphase AC induction motors operated within the nameplate ratings will run trouble-free for many years. Problems and premature failures often indicate input power system troubles, poor or deteriorating mechanical installations, or malfunctions in the driven machinery. Therefore, motor troubleshooting involves the *entire system*, not just the motor.

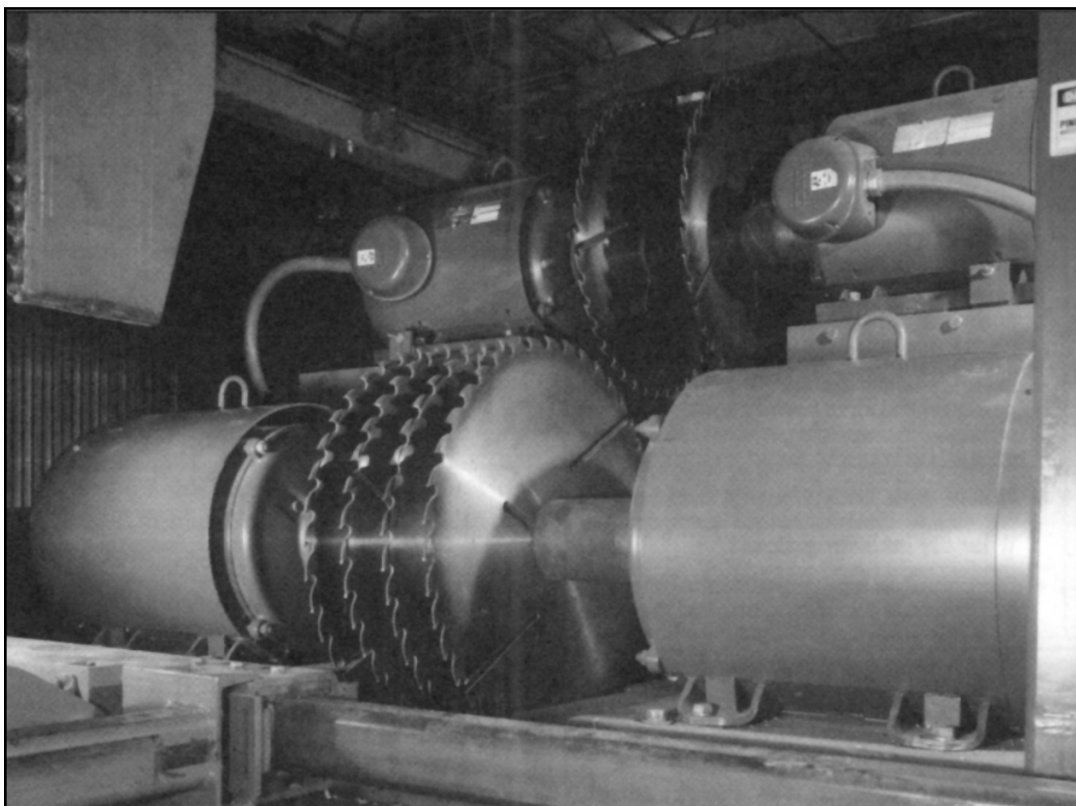

## **⚠ WARNING**

**Allow only qualified personnel to perform troubleshooting and maintenance of motors. Be sure such technicians observe standard safety precautions including those in this Troubleshooting Guide.**

## Steps for Effective Troubleshooting

Determine answers for the following questions:

- a. What are the troubles and when did they first occur?
- b. If new, did the installation ever run properly? How long?
- c. If an established installation, is the trouble new or has it been occurring for years? What changes, even if minor, occurred in the operation or maintenance of the equipment before the trouble started?
- d. Do you have accurate meter readings of current and voltage for all three phases of the input circuit? Such readings are needed to correctly determine the cause of most electrical troubles.

### WARNING



#### HIGH VOLTAGE can kill.

- Internal parts of the motor may be at line potential even when it is not rotating.
- When troubleshooting requires that measurements be taken with the input power on, the input power should be turned on only when necessary and extreme caution should be taken to avoid electric shock.
- Isolate your body from ground and do not touch electrically hot components. Wear dry insulating gloves.
- Disconnect all input power to the drive and motor before performing any maintenance.

### WARNING

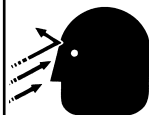

#### MOVING PARTS can injure.

- Do not operate the motor at speeds above the motor maximum safe speed.
- Operating the motor above maximum safe speed may cause parts to be ejected resulting in bodily injury.
- All motor driven components must be designed by the machine builder to operate safely at the motor maximum safe speed listed on the nameplate.

## Index to Troubles and Cures

### Section 1: MOTOR VISIBLY BURNED OUT

Trouble 1: Motor burned out Page 5

### Section 2: TROUBLES WHILE STARTING

Trouble 2: Motor won't start  
(No hum or heating) Page 6

Trouble 3: Motor won't start  
(Just hums and heats up) Page 6

Trouble 4: Overload relays trip during starting Page 6

Trouble 5: Motor starts but comes up to speed slowly Page 7

### Section 3: TROUBLES WHILE RUNNING

Trouble 6: Motor frame hot to the touch Page 7

Trouble 7: Motor overheats or overload relays trip Page 8

Trouble 8: Thru bolts feel hot Page 8

Trouble 9: Motor runs but appreciably below nameplate speed Page 9

Trouble 10: Excessive electrical noise or clatter under load Page 9

### Section 4: EXCESSIVE NOISE OR VIBRATION, PHYSICAL DAMAGE, OR BAD BEARINGS

Trouble 11: Excessive vibration and/or mechanical noise Page 9

Trouble 12: Noisy bearings Page 10

### Section 5: INPUT POWER AND INPUT CIRCUIT TROUBLES

Trouble 13: High input current in all three phases Page 12

Trouble 14: Unbalanced input current Page 12

Trouble 15: Excessive voltage drop Page 13

### Section 6: AC MOTORS USED WITH VARIABLE SPEED DRIVES

Troubles VS1-VS5: Page 14

### Section 7: BRAKE MOTORS

Trouble BM1: Brake overheats Page 15

Trouble BM2: Coil has failed Page 16

Trouble BM3: Brake is noisy during stopping Page 16

## NEW INSTALLATIONS

If a motor fails to run properly when first installed, ALWAYS check the connection arrangement of the motor leads and the input power lines. The connections must be made in conformance with either the across-the-line start diagrams on the motor nameplate or the reduced voltage start diagrams available from the motor manufacturer. If the connection arrangement is correct, proceed to identify the trouble using this Troubleshooting Guide.

All motors are suitable for full voltage or across-the-line start. See the motor nameplate for proper connection diagrams. Some *standard* Lincoln Electric motors are also capable of PWS, YDS or both as indicated in the following chart.

Syn Speed	Frame Sizes	HP Ratings	Voltage	Connection	Leads	PWS	YDS
3600	56 - 256T	1/2 - 25	230/460	Y	9	No	No
	284T - 405T	30 - 150	230/460	Δ	12	No	Yes
	444T - 445T	125 - 250	460	Δ	6	No	Yes
1800	56 - 256T	1/3 - 20	230/460	Y	9	No	No
	284T - 405T	25 - 125	230/460	Δ	12	No	Yes
	444T - 445T	125 - 250	460	Δ	12	Yes	Yes
	447T - 449T	250 - 300	460	Δ	6	No	Yes
1200	56 - 256T	1/2 - 10	230/460	Y	9	No	No
	284T - 286T	15 - 20	230/460	Δ	12	No	Yes
	324T - 365T	25 - 50	230/460	Δ	12	Yes (lower voltage only)	Yes
	404T - 405T	60 - 75	230/460	Δ	12	No	Yes
	444T - 445T	100 - 150	460	Δ	12	Yes	Yes
900	143T - 256T	1/2 - 7-1/2	230/460	Y	9	No	No

## REDUCED VOLTAGE START CONNECTION DIAGRAMS

Dual Voltage, 12 Leads  
YΔ Start Connection

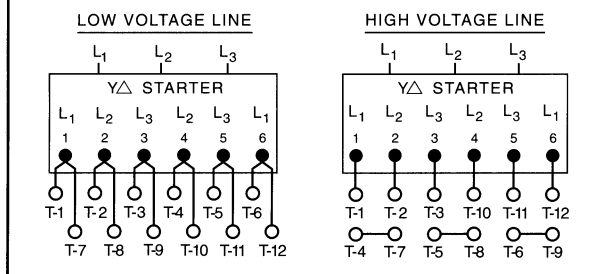

Dual Voltage, 12 Leads  
YΔ (Star-Delta) Start Connection

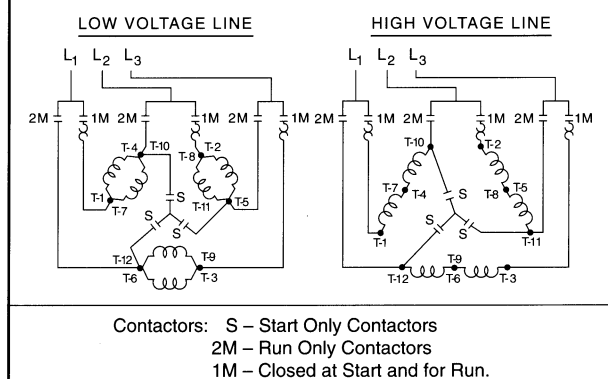

## REDUCED VOLTAGE START CONNECTION DIAGRAMS

**Single Voltage, 12 Leads  
 $\text{Y}\Delta$  Start Connection**

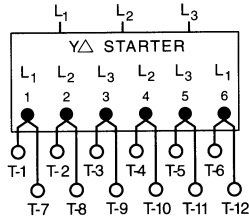

**Single Voltage, 12 Leads  
 Part Winding Start Connection**

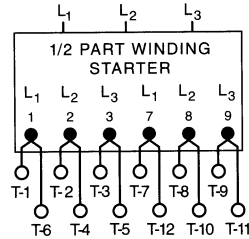

**Single Voltage, 6 Leads  
 $\text{Y}\Delta$  Start Connection**

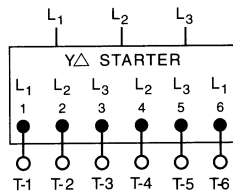

**Single Voltage, 6 Leads  
 Part Winding Start Connection**

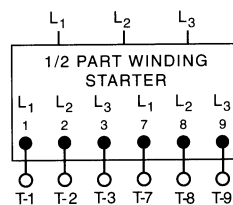

**Single Voltage, 12 Leads  
 Part Winding Start Connection**

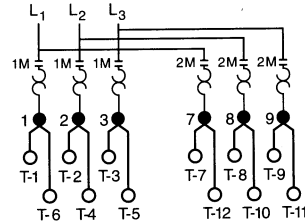

1M – Closed at start and run. 2M – Run only contactor.

**Single Voltage, 6 Leads  
 $\text{Y}\Delta$  (Star-Delta) Start Connection**

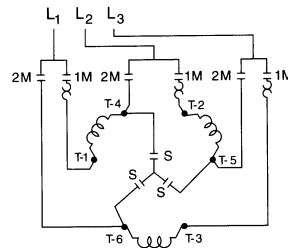

Contactors: S – Start Only Contactors  
 2M – Run Only Contactors  
 1M – Closed at Start and for Run.

**Single Voltage, 6 Leads  
 Part Winding Start Connection**

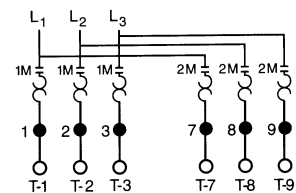

1M – Closed at start and run. 2M – Run only contactor.

## NAMEPLATE DATA IMPORTANT TO TROUBLESHOOTING

**Amps:** Current draw per phase at the motor's rated horsepower.

**Volts:** Nominal winding voltage rating. Power system voltage must be within  $\pm 10\%$ .

**Service Factor:** Continuous overload capacity of motor; ie: 50 HP x 1.15 = 57.5 HP. Current draw at service factor load would approximate the amps listed times 1.15.

**Serial Number:** Unique number identifies when the motor was manufactured.

**NEMA Code:** Indicates the motor's starting KVA code letter which can be used to approximate starting or locked rotor current draw which is typically 5 to 6 times the rated horsepower amps.

**LE CODE:** (Lincoln Electric Code) Completely describes the motor for Lincoln Electric. Have this number ready when talking with a Lincoln representative.

### Section 1: MOTOR VISIBLY BURNED OUT

#### Trouble 1: Motor burned out

(Indicated by burning odor or smoke before the motor stopped, and/or bubbled or burned paint.)

**Cause 1a:** Input power troubles, starting troubles, troubles while running, or excessive noise or vibration, physical damage to the motor, or bad bearings.

**Cure 1a:** Install a new motor. ALWAYS determine the cause of the motor's failure, starting with Section 5, pages 12 and 13, or the replacement motor may also fail before it delivers a full life expectancy.

## Section 2: TROUBLES WHILE STARTING

### Trouble 2: Motor will not start (No hum or heating.)

**NOTE:** Reset the overload relays, if tripped. Read Causes 2a through 2e. Then try to restart the motor, and look for the conditions described.

**Cause 2a:** The motor controller will not operate.

**Cure 2a:** Replace the defective controller.

**Cause 2b:** The motor hums and heats but does not start. Immediately turn off the power.

**Cure 2b:** See Trouble 3, page 6.

**Cause 2c:** The motor starts but comes up to speed too slowly. Immediately turn off the power.

**Cure 2c:** See Trouble 5, page 7.

**Cause 2d:** The motor does not start and does not hum or heat up.

**Cure 2d:** Check the voltage in all three phases at the motor connections. If there is no input voltage, locate and correct the problem in the input circuit. If the voltage is okay, replace the motor. ALWAYS determine why the motor failed, starting with Section 5, pages 12 and 13, or the replacement motor may also fail before it delivers a full life expectancy.

**Cause 2e:** The motor operates properly.

**Cure 2e:** ALWAYS determine why the overload relays tripped, starting with Section 5, pages 12 and 13, or the problem may recur. Be sure to use the overload relay size specified by the National Electrical Code (NEC) for the motor nameplate current and service factor.

### Trouble 3: Motor will not start (Just hums and heats up.)

**NOTE:** Immediately shut off the power to prevent a motor burnout. The overload relays may trip.

**Cause 3a:** Input circuit single phased (No voltage in one or two phases; could have been a temporary condition).

**Cure 3a:** Have a qualified technician check for the proper voltage in all three phases. If a single phase condition exists, correct the problem.

**Cause 3b:** Motor was single phased as indicated by heat damage to one or two phases of the motor windings.

**Cure 3b:** Replace the motor. ALWAYS have an expert check the motor windings to determine whether the single phasing occurred in the input circuit or in the motor windings. If in the input circuit, correct the single phase condition.

**Cause 3c:** Motor rotor, bearings, or driven load is locked.

**Cure 3c:** Disconnect the motor from the driven load. If the motor shaft turns freely, the trouble is in the load. Replace the motor or adjust the driven load as needed.

### Trouble 4: Overload relays trip during starting

**Cause 4a:** Overload relays undersized.

**Cure 4a:** Use the relay size specified by the National Electric Code (NEC) for the motor nameplate current and service factor.

**Cause 4b:** Motor takes too long to start.

**Cure 4b:** See Trouble 5, page 7.

## Section 2: TROUBLES WHILE STARTING

### Trouble 5: Motor starts but comes up to speed slowly

(10 or more seconds for small motors, 56-286T; 12 or more seconds for medium size motors, 324T-326T; 15 or more seconds for large motors, 364T-449T – may cause the overload relays to trip.)

**Cause 5a:** Excessive voltage drop (running voltage more than 2-3% below line voltage).

**Cause 5b:** Excessive starting load (running voltage no more than 2-3% below line voltage).

**Cause 5c:** Inadequate motor starting torque when using a reduced voltage starting (RVS) system. RVS systems lower motor starting torque as follows:

YDS — about 33% of full voltage starting torque

PWS — about 50% of full voltage starting torque

Auto Transformer starting — 25 to 64% of full voltage starting torque depending on the selected transformer tap

**Cause 5d:** Improper connections of motor leads to supply lines.

**Cure 5a:** See Trouble 15, page 13.

**Cure 5b:** Reduce the starting load or install a larger motor.

**Cure 5c:** Three possible cures include:

1. Reduce the starting load or use a larger motor.
2. Use a starting system which develops higher starting torque.
3. Reduce the time delay between the 1st and 2nd steps on the starter.

**Cure 5d:** Correct connections.

## Section 3: TROUBLES WHILE RUNNING

### Trouble 6: Motor frame hot to the touch

**Cause 6a:** The heat may be normal or a sign of overheating, depending on the motor's ventilation system design. For example:

- a. The frame of Lincoln extruded aluminum frame motors transfers heat from the windings and laminations to the external air. The frame normally gets too hot to touch.
- b. The frame of Lincoln steel frame TEFC motors allow internal cooling air to pass between the frame and the laminations. The frame remains relatively cool.

**Cure 6a:** If overheating is suspected, go to Trouble 7, page 8.

Sample TEFC Surface Temperatures

Frame Material	HP	RPM	Frame Temperature <sup>(1)</sup>	
			°C	°F
Extruded Aluminum	5	1800	65 <sup>(2)</sup>	150 <sup>(2)</sup>
	10	1800	70 <sup>(2)</sup>	158 <sup>(2)</sup>
Steel	25	1800	40 - 45	105 - 115
	50	1800	40 - 45	105 - 115
	100	1800	40 - 45	105 - 115

<sup>(1)</sup> Temperatures were calculated for motors operating at full load and 40°C ambient.

<sup>(2)</sup> Surface temperature between fins.

## Section 3: TROUBLES WHILE RUNNING

### Trouble 7: Motor overheats or overload relays trip

*Before considering Causes 7a through 7f, proceed as follows:*

**Step 1:** Look at the motor. If it is visibly burned out, go to Trouble 1, page 5. If it looks OK, try to restart the motor.

**Step 2:** If it will not start, go to Trouble 2, page 6. If it does start, ALWAYS determine the cause of the trouble beginning with Section 5, pages 12 and 13.

**Step 3:** If the cause of the overheating was not located during Steps 1 and 2, proceed with Causes 7a through 7f.

**NOTE:** Thermostats and Thermistors - these optional devices are installed in some motor windings and wired to the motor control system. Their function is to signal the motor control system when the motor temperature has exceeded the thermostat or thermistor's predetermined trip point. Motor overheating can result from overload, input power problems, restricted ventilation or above normal ambient temperature. Unlike overload relays, thermostats and thermistors automatically reset when they cool. Therefore, when a motor is taken off line without tripping the overload relay, check the nameplate to see if thermostats or thermistors are installed.

**Cause 7a:** Overload relays undersized.

**Cure 7a:** Use the relay size specified by the National Electric Code (NEC) for the motor nameplate current and service factor.

**Cause 7b:** Motor overloaded. This condition may be determined by measuring for excessive input current in all three phases per Trouble 13, page 12.

**Cure 7b:** Reduce the load or install a larger motor.

**Cause 7c:** Too many starts and/or intermittent overloads during the operating cycle.

**Cure 7c:** Reduce the number of starts, the number of intermittent overloads, the size of the overload peaks, or install a larger motor.

**Cause 7d:** Ambient temperature at the motor above 40°C (104°F).

**Cure 7d:** Reduce the ambient temperature or install a motor designed and rated for the specific ambient conditions.

**Cause 7e:** Poor motor ventilation.

**Cure 7e:** Verify cooling air is flowing freely over or through the motor and the motor fan operates properly. Keep the air passages over and through the motor clear.

**Cause 7f:** High ambient temperature at the motor controller.

**Cure 7f:** Reduce the ambient temperature at the controller.

### Trouble 8: Thru bolts feel hot (Paint blistered.)

**Cause 8a:** Thru bolts loose.

**Cure 8a:** Tighten the thru bolts to the specified torque.



## Section 3: TROUBLES WHILE RUNNING

### Trouble 9: Motor runs, but appreciably below nameplate speed

**Cause 9a:** Speed measurement may be inaccurate.

**Cause 9b:** High overload. Motor will overheat and may trip the overload relays.

**Cause 9c:** Excessive voltage drop. A 10-15% voltage drop cuts speed by approximately 1-2%. Question a report of high speed drops caused by large voltage drops.

**Cure 9a:** Check the measurement method and equipment.

**Cure 9b:** Reduce the overload or install a larger motor.

**Cure 9c:** See Trouble 13, page 12.

### Trouble 10: Excessive electrical noise or clatter under load

**Cause 10a:** System single phased. Motor may overheat and trip the overload relays.

**Cure 10a:** Shut the power off, then on. If the motor hums and heats but does not start, single phasing exists — See Trouble 3, page 6.

## Section 4: EXCESSIVE NOISE OR VIBRATION, PHYSICAL DAMAGE AND BAD BEARINGS

**NOTE:** The next Troubles, 11 and 12, are mostly caused by poor or deteriorating installation of the motor base, motor, driven load, sheaves or coupling. The motor and driven load must be mounted firmly and solidly with precise alignment or vibration will develop leading to mechanical failures. Foundations must be secure and stable. Shims must be as few in number as possible to insure that all motor feet are mounted in the same geometrical plane. Consider tapered shims, if necessary.

*These are COMMON FAILURES! If motors and driven loads are properly mounted, these failures can be virtually eliminated.*

### Trouble 11: Excessive vibration and/or mechanical noise

(It may originate in the driven load, coupling, or motor.)

**NOTE:** Loosening one motor foot at a time and listening may identify stresses caused by an improper mounting.

**Cause 11a:** Poor or loosened motor or driven load mounting.

**NOTE:** Consider Causes 11b, 11c, and 11d in sequence.

**Cause 11b:** Driven load out of balance.

**Cure 11a:** Be sure the foundations for the motor and the driven load are rigid, the feet of each are properly shimmed and in the same plane, and the mounting bolts are tight. Check any grouting for cracks.

**Cure 11b:** Disconnect the motor from the load and restart. If the noise and vibration are gone, the problem is in the load. Correct the problem.

## Section 4: EXCESSIVE NOISE OR VIBRATION, PHYSICAL DAMAGE AND BAD BEARINGS

### Trouble 11: Excessive vibration and/or mechanical noise

(It may originate in the driven load, coupling, or motor.)

**NOTE:** Loosening one motor foot at a time and listening can often identify stresses caused by an improper mounting.

**Cause 11c:** Sheave or coupling out of balance.

**Cure 11c:** Remove the sheave or coupling. Secure a *half key* in the motor shaft keyway and restart the motor. If the vibration and noise is gone, the trouble is in the sheave or coupling.

**Cause 11d:** Motor out of balance.

**Cure 11d:** If the problem persists after disconnecting the sheave or coupling, recheck the motor mounting. If the mounting is ok, the problem may be bad bearings or a bent shaft. Replace the motor bearings or the motor. ALWAYS determine the root cause of the bearing failure (see Trouble 12) or the bent shaft to prevent recurrence of the problem.

**Cause 11e:** Misalignment in close coupled application.

**Cure 11e:** Check the alignment between the motor shaft and driven load. Realign as needed.

**Cause 11f:** Normal motor noise amplified by resonant mounting.

**Cure 11f:** Cushion the mounting or dampen the source of the resonance.

### Trouble 12: Noisy bearings

**Cause 12a:** Poorly fit or damaged bearings.

**Cure 12a:** Listen to each bearing for the following sounds:

1. Smooth mid-range hum - normal fit; bearing OK.
2. High whine - Tight internal fit; replace the bearing and check the fit.
3. Low rumble - Loose internal fit; replace the bearing and check the fit.
4. Rough clatter - Bearing destroyed; replace bearing. ALWAYS determine the root cause of the bearing failure or the trouble may recur.

**NOTE:** For long bearing life, avoid the following:

1. Poor or loose mountings, misalignment, excessive vibration and high belt tension.
2. Over greasing. More damage is done by excessive grease and contaminants introduced during greasing than by lack of greasing. DO NOT grease more than recommended by the motor manufacturer.
3. Water, dirt or chemicals entering the motor. Consider totally enclosed motors when such contaminants are a problem.
4. Standard Lincoln motors are lubricated with a high quality polyurea based grease which is not compatible with lithium based greases. Mixing of polyurea and lithium based greases may cause a loss of lubricant leading to bearing and possibly motor failure.

**Section 4: EXCESSIVE NOISE OR VIBRATION, PHYSICAL DAMAGE AND BAD BEARINGS**

**Trouble 12: Noisy bearings**

<b>Bearing Sizes Used in Lincoln Motors — Extruded Aluminum and Steel Frames</b>			
<b>Frame Size</b>	<b>Drive End</b>	<b>Opposite Drive End</b>	
		<b>Single Shaft</b>	<b>Double Shaft</b>
56 - 56H	203	203	203
143T - 145T	205 (206 JM, JP)	203	203
182T - 184T	207	205	205
213T - 215T	208 (209 JM, JP)	206	206
254T - 256T	309	208	208
284T/TS - 286T/TS	310	209	310
324T/TS - 326T/TS	311	309	311
364T/TS - 365T/TS	313	311	313
404T/TS - 405T/TS	315	313	315
444T/TS - 445T/TS	318 (315 3600 RPM) 318 (max capacity – 250 HP 1800 RPM)	315	315

<b>Bearing Sizes Used in Lincoln Motors — Cast Iron Frames (TEFC)</b>		
<b>Frame Size</b>	<b>Drive End</b>	<b>Opposite Drive End</b>
143T - 145T	205	203 (205 w/C-Face)
182T - 184T	306	205 (306 w/C-Face)
213T - 215T	307 (308 w/C-Face)	207 (307 w/C-Face)
254T - 256T	309	208 (209 w/C-Face)
284T/TS - 286T/TS	310	210
324T/TS - 326T/TS	312	211
364T/TS - 365T/TS	313	213
404T/TS - 405T/TS	315	215
444T/TS - 445T/TS	318	315
447T/TS - 449T/TS	320 (max. capacity)	318

## Section 5: INPUT POWER AND INPUT CIRCUIT TROUBLES

**NOTE:** These Troubles, as well as motor overloads, are best identified by having a qualified technician, using properly calibrated meters, make the following electrical checks. Completing the entire process is also recommended even when the problem appears to be solved with an early step. Also, remember that troubles can be intermittent and will not necessarily be identified during these checks. Knowing the history of recurring problems is crucial to a final solution.

**Step 1:** Reset the overload relays, if tripped, start the motor, and go to Step 2. If the motor won't start, see Troubles 1 and 2, pages 5 and 6.

**Step 2:** Measure the current in all three phases with the motor operating under load. If there is more than a 5% deviation between phases, immediately shut the power off and go to Trouble 14. If the current is balanced, the motor is probably overloaded. Go to Step 3. To confirm an overload, note the input current relative to the nameplate full load current and proceed with Step 4.

**Step 3:** Measure the input voltage in all three phases with the motor off and with the motor running. Taking meter readings at the supply side and motor side of the controller and at the motor terminal box connections are recommended. If the voltage is 10% or more above or below the motor nameplate voltage with the motor both stopped and running, go to Trouble 13, page 10. If the voltage drops more than 2-3% after starting the motor, go to Trouble 15, page 13. If the voltage is OK, proceed with Step 4.

**Step 4:** Disconnect the motor from the load, start the motor, and measure the idle current in all three phases. If the idle current matches the normal motor idle current available from the manufacturer, but the full load current is high, the motor is overloaded — see Cause 13b, page 12.

### Trouble 13: High input current in all three phases

**Cause 13a:** Line voltage 10% or more above or below the motor nameplate voltage.

**Cause 13b:** Motor overloaded (voltage OK and load current high confirmed by normal idle current - see Steps 2 and 4).

**Cure 13a:** Either replace the motor with one of the correct voltage rating or ask the power company to adjust the line voltage possibly using a different transformer tap.

**Cure 13b:** Reduce the load or install a larger motor.

### Trouble 14: Unbalance input current

(5% or more deviation between phases from the average input current.)

**NOTE:** A small voltage unbalance will cause a large current unbalance. Depending upon the magnitude of the unbalance and size of the driven load, the current in one or two lines may exceed the rating of the motor.

**Cause 14a:** Unbalanced line voltage, measured at the motor terminals, caused by the following:

1. Unbalanced power supply (unequal transformer tap settings)
2. Unbalanced system loading
3. High resistance connection
4. Power line for 1 or 2 phases undersized
5. Improper functioning capacitor bank
6. Defective motor

**Cure 14a:** Locate and correct the cause of the unbalance. If in doubt as to whether the unbalance is in the power supply or the motor, rotate all three power line connections to the motor by one position — i.e., move line #1 to #2 motor lead, line #2 to #3 motor lead, and line #3 to #1 motor lead:

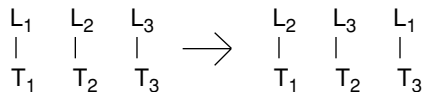

L<sub>1</sub>, L<sub>2</sub>, and L<sub>3</sub> represent input power leads.

T<sub>1</sub>, T<sub>2</sub>, and T<sub>3</sub> represent motor leads for a 3 lead motor.

For a 6, 9 or 12 lead motor, they represent a combination of two or more leads.

1. If the unbalance follows the power lines, the unbalance is in the lines.
2. If the unbalance follows the motor leads, the unbalance is in the motor.

Correct the unbalance in the power lines or replace the motor as appropriate.

## Section 5: INPUT POWER AND INPUT CIRCUIT TROUBLES

### Trouble 15: Excessive voltage drop (Running voltage more than 2-3% below supply voltage.)

**NOTE:** The voltage drop is high during starting because the starting current reaches 5-6 times the normal full load current.

**Cause 15a:** Motor overloaded (voltage normal and load current high confirmed by normal idle current - see Steps 2 and 4 on page 12).

**Cause 15b:** Insufficient power supply.

**Cause 15c:** Undersized input power lines.

**Cause 15d:** High resistance connections.

**Cause 15e:** Each phase input lead in a separate steel conduit.

**Cure 15a:** Reduce the load or install a larger motor.

**Cure 15b:** Request a more adequate power supply from the power company.

**Cure 15c:** Be sure the supply lines are of sufficient size as specified by the National Electric Code (NEC) for the motor nameplate current and service factor.

**Cure 15d:** Check the connections in the system and at the motor. Fix poor connections.

**Cure 15e:** When using magnetic metal conduit, all three input leads must be in a single conduit as required by the National Electric Code.

### Performance Characteristic Changes When Motors are Operated on High or Low Voltages (at Rated Frequency)

Performance Characteristic	Change, Relative to Performance at Rated Voltage <sup>(1)</sup>	
	When Actual Voltage is 10% Above Rated Voltage	When Actual Voltage is 10% Below Rated Voltage
<b>STARTING — PULL UP — BREAK DOWN</b>		
Current Torque	Increases 10 to 12% Increases 21 to 25%	Decreases 10 to 12% Decreases 19 to 23%
<b>IDLE</b>		
Current 1800-1200-900 RPM Motors 3600 RPM Motors	Increases 12 to 39% Increases 28 to 60%	Decreases 10 to 21% Decreases 21-34%
<b>RATED LOAD</b>		
Current (1800 & 3600 RPM Motors Only) 143T-182T 184T-256T 284T-445T	Varies -4 to +11% Decreases 1 to 10% Decreases 0 to 7%	Varies -11 to +4% Increases 1 to 10% Increases 0 to 7%
Current (1200 & 900 RPM Motors Only) These motors do not follow the above pattern. Most will respond to a 10% overvoltage with an increase, as much as 15%, in input current. A similar reduction in input current is characteristic of a 10% reduction in input voltage.		
Power Factor <sup>(2)</sup> Efficiency <sup>(2)</sup> Speed Percent Slip	Decreases 5 to 8% Little Change Increases 1% Decreases 1.0%	Increases 2% Decreases 2% Decreases 1.5% Increases 1.5%

<sup>(1)</sup> See the B1T series of bulletins for performance data at rated voltages.

<sup>(2)</sup> Note at 3/4 and 1/2 load these changes are approximately the same.

## Section 6: AC MOTORS USED WITH VARIABLE SPEED DRIVES

Listed below are additional problems which can occur when an AC motor is used with a variable speed drive.

**Trouble VS1: Excessive electrical noise** (humming and buzzing) and motor overheating.  
Occurs below half speed.

**Cause VS1:** Voltage boost may be too high.

**Cure VS1:** Use the proper volts/Hertz ratio.

**Trouble VS2: Excessive mechanical noise** (sounds like stones in the air gap)

**Cause VS2:** The current loop is unstable.

**Cure VS2:** Check for loose encoder coupling.

**Trouble VS3: Excessive mechanical noise** (grinding and clanking sounds)

**Cause VS3:** Noise in operating frequency range.

**Cure VS3:** Program the drive to skip the frequency or frequencies where noise occurs.

**Trouble VS4: Motor overheats**

**Cause VS4:** If the motor has an external fan (TEBC), air is blowing in the wrong direction for cooling.

**Cure VS4:**

1. Single phase blower motors - check for correct wiring of the run capacitor.
2. Three phase blower motors - interchange any two input phases to the blower motor.

**Trouble VS5: Motor will not start with drive in the across-the-line start mode**

**Cause VS5:** Volts/Hertz curve does not match motor.

**Cure VS5:** Confirm volts/Hertz on nameplate.

## Section 7: BRAKE MOTORS

The information presented below supplements the troubleshooting section of the installation and service instructions for specific brake models. Before any service work is performed, the installation and service instructions and this information should be thoroughly read. All caution and warning instructions must be observed.

### Trouble BM1: Brake overheats (or friction discs and/or stationary discs burn or fracture)

**Cause BM1a:** Solenoid may not be energizing and releasing the brake.

**Cure BM1a:**

1. Check voltage at the coil and compare to the coil and/or nameplate rating.
2. Whether brake is AC or DC, a voltage drop may be occurring. If excessive drop in voltage is noted, check wire size of power source. Correct as needed. Request Sheet 300.1 from Stearns Division for coil voltage check procedure.
3. If brake is DC solenoid style, check switch actuation and condition of coil. If actuating arm is bent, replace plunger. Check switch contacts. If pitted, replace switch. Request Sheet 300.1 from Stearns Division for switch air gap values.
4. Check linkage for binding. Do not over look bent, worn or broken plunger guides as a possible cause for binding. Request Sheet 300.1 from Stearns Division for approximate pressure values to switch air gap values.

**Cause BM1b:** Worn slots or teeth of endplate.

**Cure BM1b:** Check slots or teeth of endplate for wear at the areas where stationary discs are located. Grooves in the slots or teeth can cause hang-up or even breakage of ears or teeth of stationary discs. If grooving is noted, replace endplate.

**Cause BM1c:** Wear adjustment screws need adjustment.

**Cure BM1c:** On all 55,XXX and 56,X00 Series Brakes, two screws are used for wear adjustment. They may be misadjusted. Remove support plate assembly. Rotate both screws counterclockwise until heights are equal at approximately 1/4" for multiple disc brakes and 1/2" for single disc brake as measured by depth micrometer on the motor side of the support plate. Reinstall support plate and adjust solenoid air gap by rotating each screw clockwise an equal amount until the air gap as specified in the appropriate installation and service instruction sheet, for that brake series, is attained.

**Cause BM1d:** Mounting dimensions not to specifications.

**Cure BM1d:** Check mounting face runout, mounting rabbet eccentricity and shaft runout. Values should be within limits of NEMA specifications or as specified on Stearns Division drawing SA-534. Correct as required.

**Cause BM1e:** Bolt heads too high.

**Cure BM1e:** On brakes with mounting bolts of endplate under friction disc(s), check that heads of bolts do not extend above wear surface of endplate.

**Cause BM1f:** Vertical mounting pins out of position.

**Cure BM1f:** On vertical brakes, check the vertical mounting pins having a shoulder to be sure shoulder of pin is flush with wear surface of endplate or pressure plate. Be sure pins are straight and the pressure plate and stationary disc(s) are free to slide on the pins. Be sure springs and spacers are installed in proper order.

**Cause BM1g:** Heater not functioning.

**Cure BM1g:** If a heater is supplied and excess rusting has occurred in brake, check power source to heater to be sure it is operating and that heater is not burned out.

**Cause BM1h:** Manual release not functioning.

**Cure BM1h:** Check manual release to be sure it operates properly, including automatic return. Be sure spring is not broken or deteriorated.

**Cause BM1i:** Improper solenoid plunger position.

**Cure BM1i:** The installed position of all horizontal brakes with a solenoid is with the solenoid plunger vertically above the solenoid frame. With certain brake stylers, upside down installation can result in interference with the solenoid link preventing the plunger from seating. In cases of upside down installations, remove brake and rotate to have the solenoid and plunger as close to vertical as possible. Always check manual release operation on all brakes before starting motor.

<b>Cause BM1j:</b> Improper pressure spring length.	<b>Cure BM1j:</b> Check pressure spring(s) length to insure correct and/or equal height. For original spring lengths, request Sheet 300.1 from Stearns Division.
<b>Cause BM1k:</b> Wrong or non-approved parts.	<b>Cure BM1k:</b> Check for homemade or substitute parts that were not manufactured or supplied by Stearns Division. Usually the substituted parts can be recognized because they do not have the finished manufacturing appearance. Check, especially, such items as pressure spring, friction discs and hubs.
<b>Cause BM1l:</b> Incorrect brake for application.	<b>Cure BM1l:</b> Check nameplate to see if it has been restamped. Incorrect information on nameplate may lead to ordering or obtaining incorrect parts or incorrect installation of brake.

**Trouble BM2: Coil has failed**

<b>Cause BM2a:</b> Reference Cause BM1a.	<b>Cure BM2a:</b> Reference Cure BM1a.
<b>Cause BM2b:</b> Broken plunger guides.	<b>Cure BM2b:</b> Check plunger guides for breakage. A broken plunger guide may not permit plunger to seat against frame.
<b>Cause BM2c:</b> Wrong or non-approved coil.	<b>Cure BM2c:</b> Use only Stearns Division replacement coils. Substitute coils may not have the same pull characteristics as original coils and can either fail or cause damage to the solenoid.

**Trouble BM3: Brake is noisy during stopping**

<b>Cause BM3a:</b> Reference Cause BM1d.	<b>Cure BM3a:</b> Reference Cure BM1d.
<b>Cause BM3b:</b> Friction disc(s) rubbing inside of endplate.	<b>Cure BM3b:</b> Check for signs of the outside diameter of the friction disc(s) rubbing on the inside diameter of the endplate. This would indicate brake is eccentric with respect to the motor shaft and/or the shaft is deflecting during a stop. Check alignment per Cure BM1d and/or shaft diameter. If realignment does not correct the problem, a larger diameter shaft may be required. Shaft deflection may also be caused by excessive overhang of the brake from motor bearing. Additional shaft support may be required.
<b>Cause BM3c:</b> Inadequately sized clearance hole.	<b>Cure BM3c:</b> In cases where motor shaft extends through a fan casing or guard, the clearance hole may not be adequate. Rubbing of the shaft may occur causing a noise during a stop. If required, enlarge clearance hole.
<b>Cause BM3d:</b> Poorly fit or damaged bearings.	<b>Cure BM3d:</b> Check for bad motor bearings per Trouble 12, page 10. Check for excessive shaft endfloat. Correct as required.

Section 7 reprinted with permission from Rexnord Corporation, Stearns Division, 120 North Broadway, Milwaukee, WI 53202. Phone: (414)272-1100 Fax: (414)277-4364.



THE  
**LINCOLN ELECTRIC  
 COMPANY**

CLEVELAND, OHIO 44117-2525 U.S.A.

For more information call:  
**1-800-MOTOR-4-U**

**NOTE:** All listed reference bulletins are available from your nearby Lincoln Electric Sales and Technical Support Office or The Lincoln Electric Company, 22800 St. Clair Avenue, Cleveland, Ohio 44117-2525.